

NEW COLLECTION

PIVOT

SYSTEM

2023



ALUDOORS®
Doors & Systems

MODEL RANGE

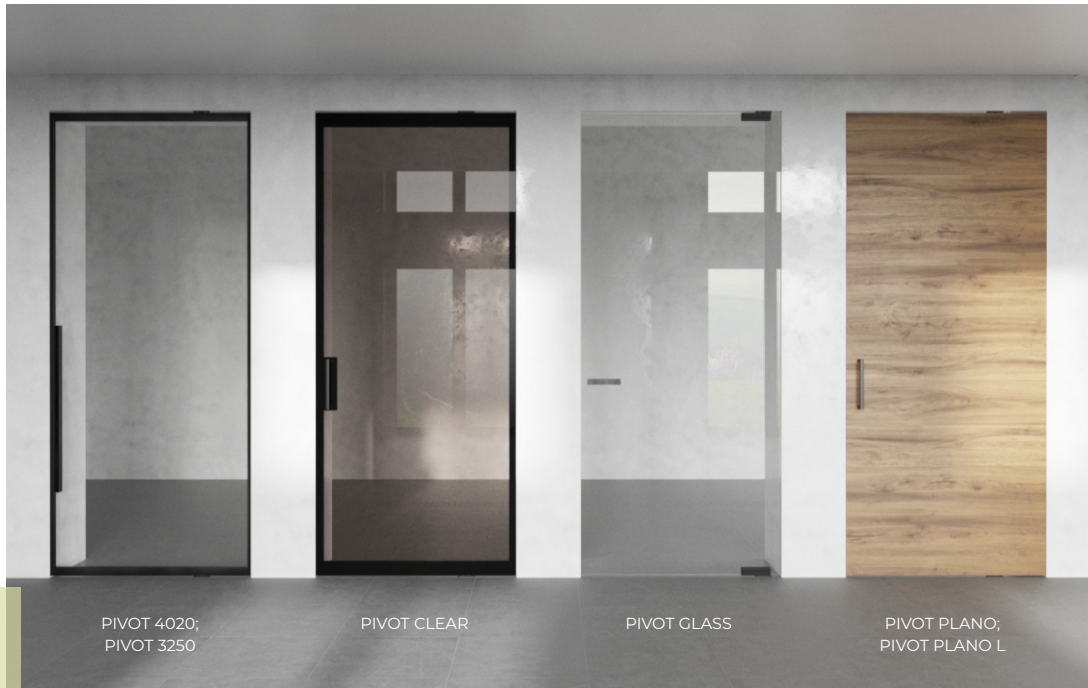

models

PIVOT 4020;
PIVOT 3250

PIVOT CLEAR

PIVOT GLASS

PIVOT PLANO;
PIVOT PLANO L

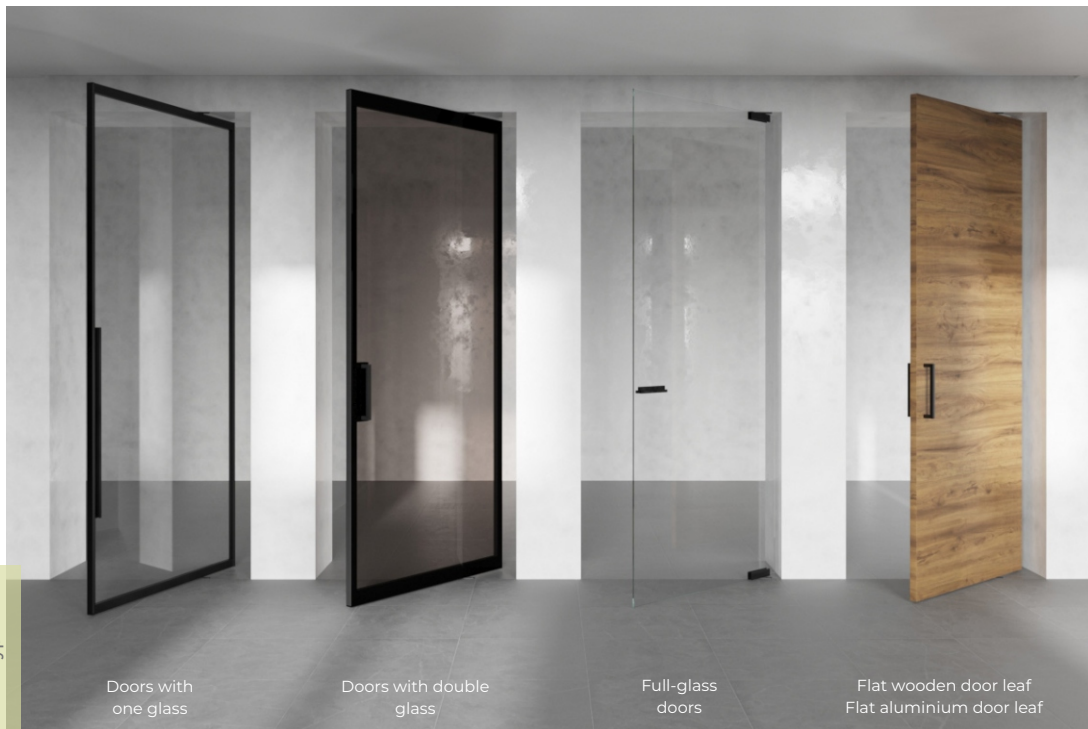

door types

Doors with
one glass

Doors with double
glass

Full-glass
doors

Flat wooden door leaf
Flat aluminium door leaf

The Pivot System opening system is compatible with almost all models of AluDoors doors. The minimum distance for installing the pivot mechanism from the edge of the door leaf is 85 mm, and the maximum distance is 1/2 of the door leaf (for door widths greater than 1300 mm).

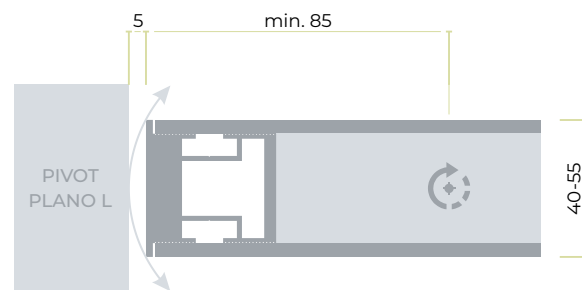
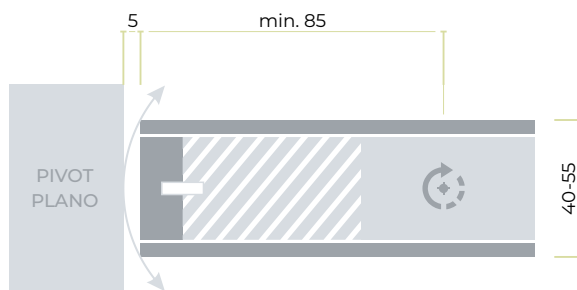
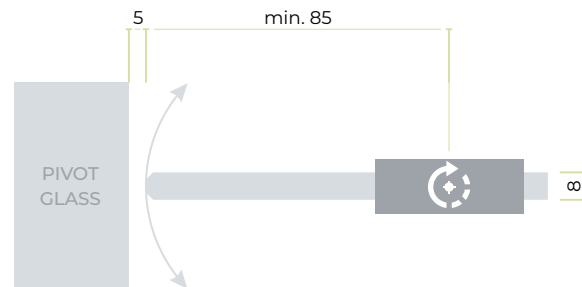
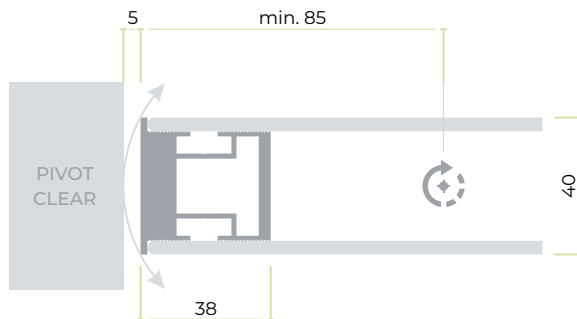
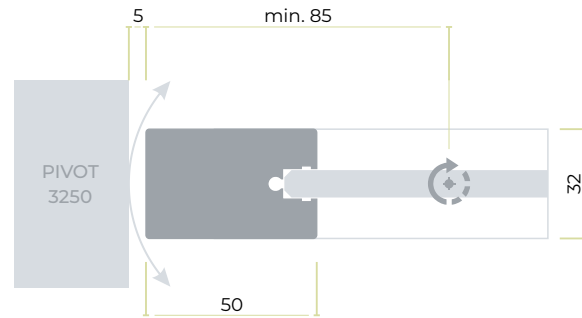
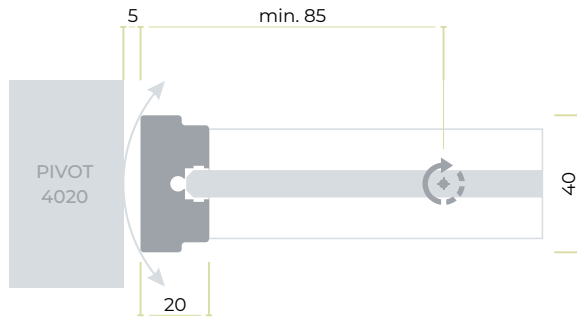

The model range of doors with a single glass Pivot System 4020 and 3250

pivot 4020



Pivot System 4020 / 01



Pivot System 4020 / 02



Pivot System 4020 / 03

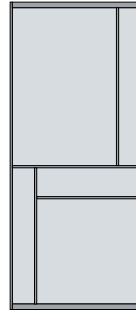

Pivot System 4020 / 04



Pivot System 4020 / 05



Pivot System 4020 / 06

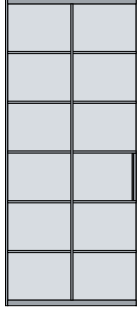

Pivot System 4020 / 07

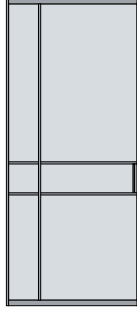

Pivot System 4020 / 08

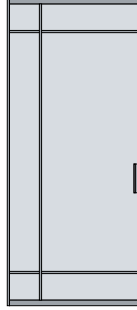

Pivot System 4020 / 09



Pivot System 4020 / 10

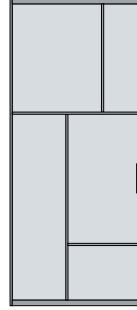

Pivot System 4020 / 11

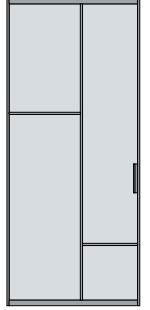

pivot 3250



Pivot System 3250 / 01

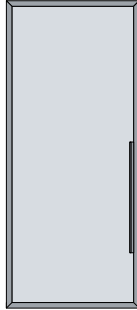

Pivot System 3250 / 02



Pivot System 3250 / 03

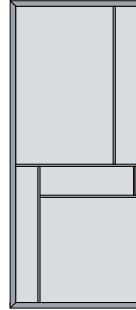

Pivot System 3250 / 04



Pivot System 3250 / 05



Pivot System 3250 / 06

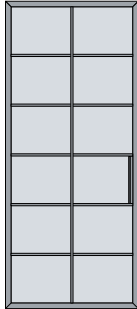

Pivot System 3250 / 07

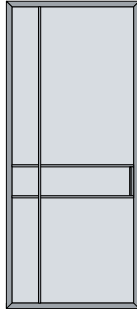

Pivot System 3250 / 08

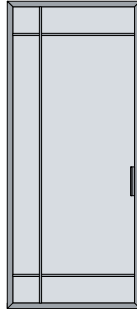

Pivot System 3250 / 09

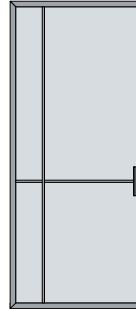

Pivot System 3250 / 10

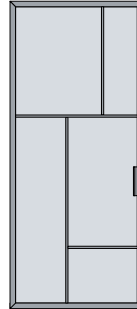

Pivot System 3250 / 11

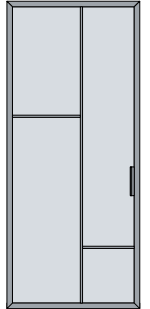

AluDoors Pivot 4020 single glass pivot doors combine the elegant style of the Light series doors and the minimalism of a door frame without unnecessary elements. They also pair perfectly with regular swing doors and sliding systems based on the Light model.

The Pivot 4020 model features thin vertical posts and wider horizontal ones, which adds to the lightweight construction of the door.

PIVOT
SYSTEM
4020/01



PIVOT
SYSTEM
3250/09



The wide profile of the door leaf around the perimeter distinguishes the AluDoors Pivot 3250 model from the 4020 model with a single glass panel and axial opening. At the same time, with its sleek design, the pivot doors have a

practical side for modern interior. The Pivot System doors allow closing a two-meter door opening and ensuring convenient use, as the opening radius into the room will be only one meter and will not be obstructive.



PIVOT
SYSTEM
3250/07

PIVOT
SYSTEM

C L E A R



ALUDOORS®
Doors & Systems

The Pivot System Clear model combines all the advantages of pivot doors while also having a massive appearance thanks to its double glazing.

The AluDoors Pivot Clear model typically has large dimensions, but thanks to high-quality European technology, the pivot mechanism always provides easy and silent movement of the doors. All Pivot doors are equipped with a two-way opening system, which provides even more convenience for users. Innovative ideas in the design process allow for the creation of a line of pivot doors without the need for a door frame or door casings.



PIVOT

S Y S T E M

GLASS

The AluDoors Pivot Glass model allows for even more lightness and freedom in interior design, as the system allows for making tall and wide glass doors without unnecessary framing. One can implement a designer's vision and close a three-meter-wide door opening with Pivot Glass double doors, which will look stylish and support the main concept of lightness and minimalism.



PIVOT
SYSTEM
PLANO L



The Pivot System Plano doors are constructed as panel doors and perfectly complement wall panels. Natural veneer or painting combine the classic execution of Plano doors with an innovative pivot mechanism. The Plano L model uses an aluminum frame door leaf, which creates a

beautiful combination of veneer and metal ends of the doors. The AluDoors Pivot Plano model shifts the focus towards technology. Even modern-traditional interiors feel completely new with these doors.

PIVOT SYSTEM INSTALLATION

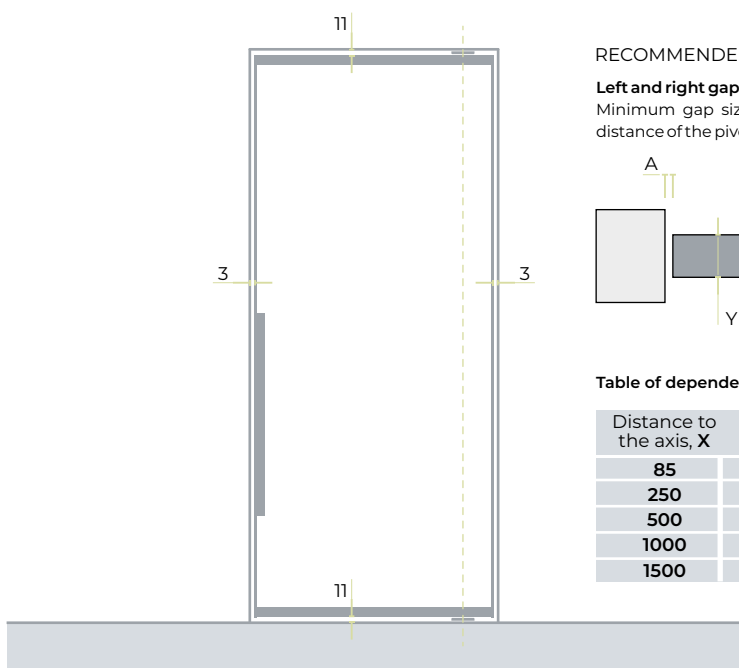
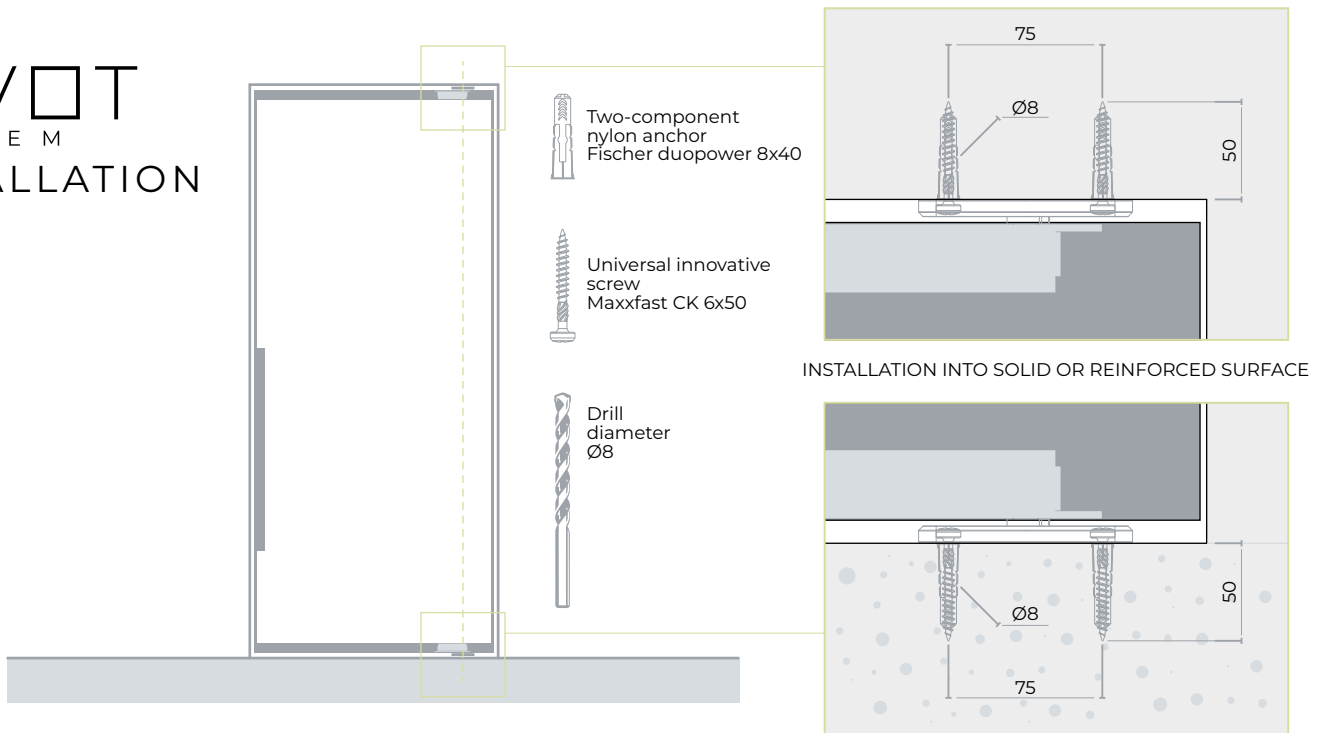

RECOMMENDED GAP SIZES

Left and right gaps (A=B)

Minimum gap sizes depend on the door thickness and the distance of the pivot mechanism installation axis.

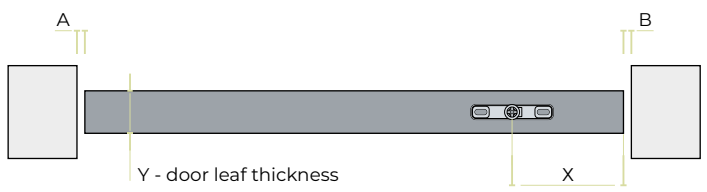
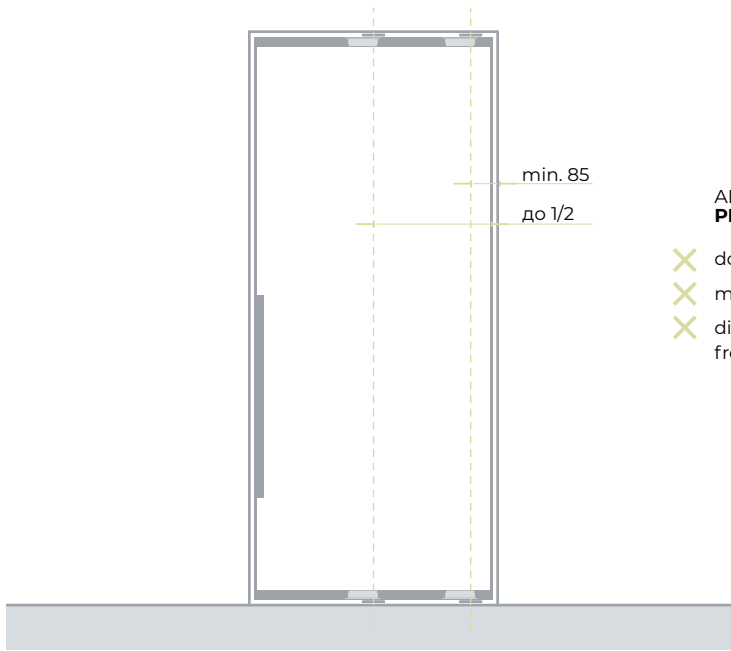

Table of dependency of left and right gaps (A=B)

Distance to the axis, X	Door leaf thickness Y, mm		
	40	50	60
85	4	5	7
250	3	3	4
500	2	3	3
1000	2	2	3
1500	2	2	2

PIVOT SYSTEM INSTALLATION



ALUDOORS PIVOT SYSTEM

- ✘ door width ≤ 1250 mm
- ✘ maximum weight of the door leaf ≤ 75 kg
- ✘ distance from the edge of the door leaf to axis X ranging from **85 mm** to **1/2**

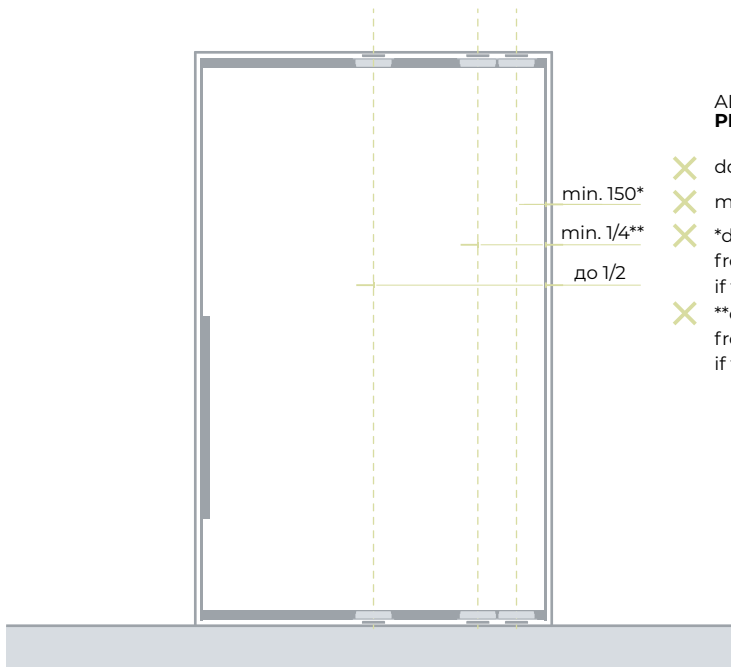

ALUDOORS PIVOT SYSTEM XL

- ✘ door width ≤ 2250 mm
- ✘ maximum weight of the door leaf ≤ 150 kg
- ✘ *distance from the edge of the door leaf to axis X ranging from **150 mm** to **1/2**
if the door leaf width ≤ 1250 mm (and the weight >75 kg)
- ✘ **distance from the edge of the door leaf to axis X ranging from **1/4** to **1/2**
if the door leaf width is from 1250 to 2250 mm

PIVOT SYSTEM HOLD POSITION

DOOR LEAF FUNCTION

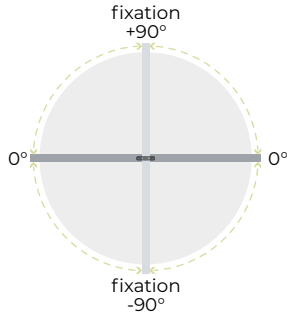

360° rotation with 90° fixation

The built-in silent fixation function is activated in the +90°, 0°, and -90° positions.

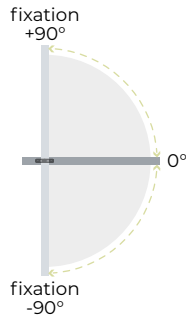

180° rotation with 90° fixation

The built-in silent fixation function is activated in the +90°, 0°, and -90° positions.

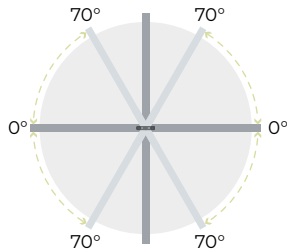

AUTOMATIC CLOSING

The pivot hinge will start closing automatically at an angle of 70°. Both AluDoors pivot systems are equipped with Suspa 420N gas closers.

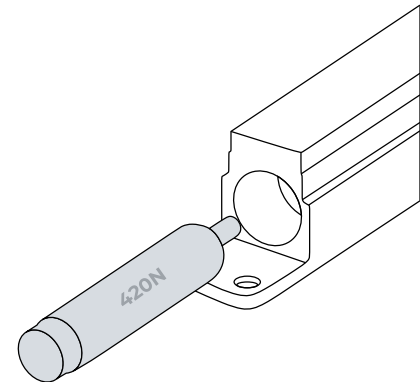
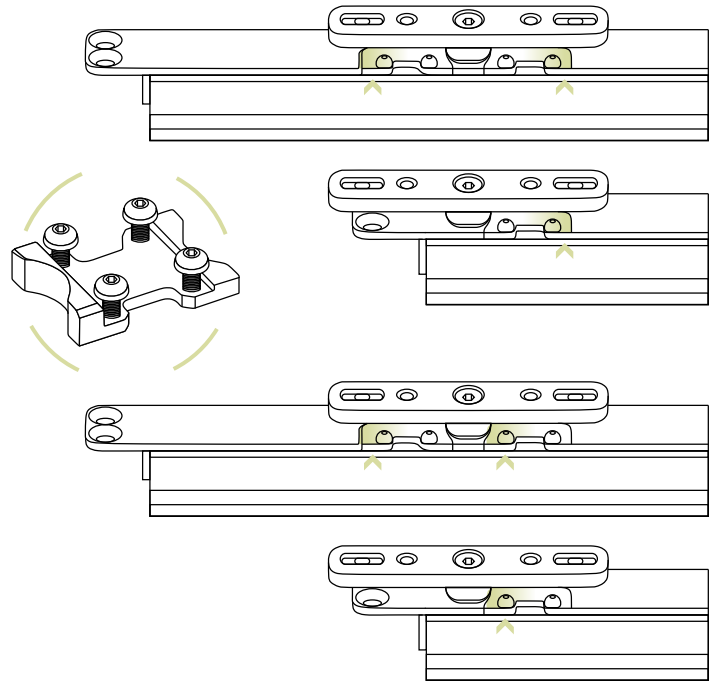

ADDITIONAL POSITIONING SYSTEMS

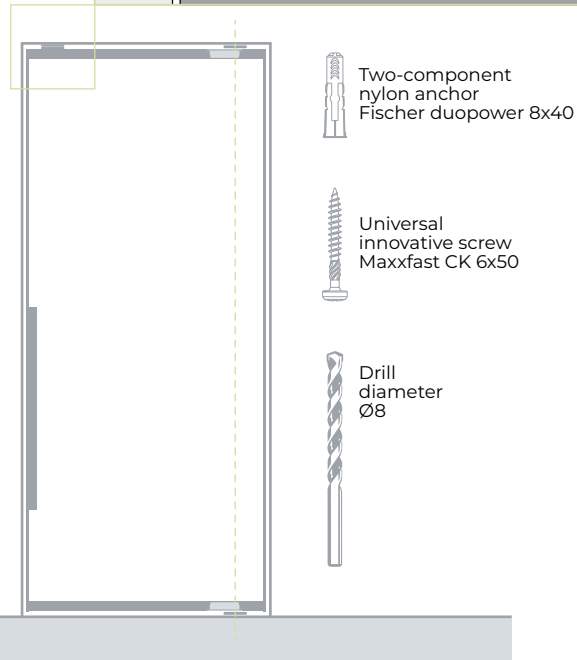
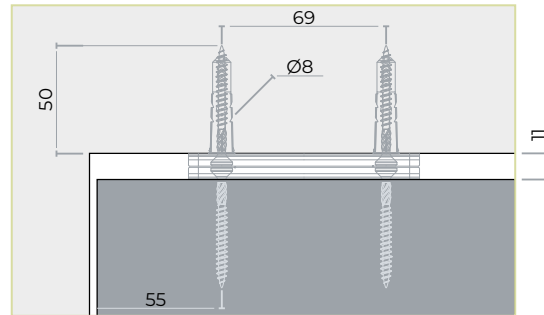
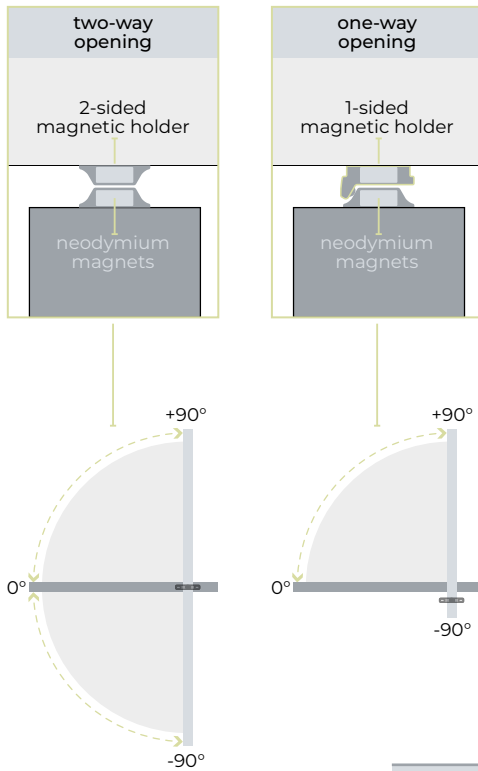

PIVOT SYSTEM REBATED DOORS

IMPLEMENTATION IS POSSIBLE ON THE BASIS OF THE PIVOT PLANO MODEL

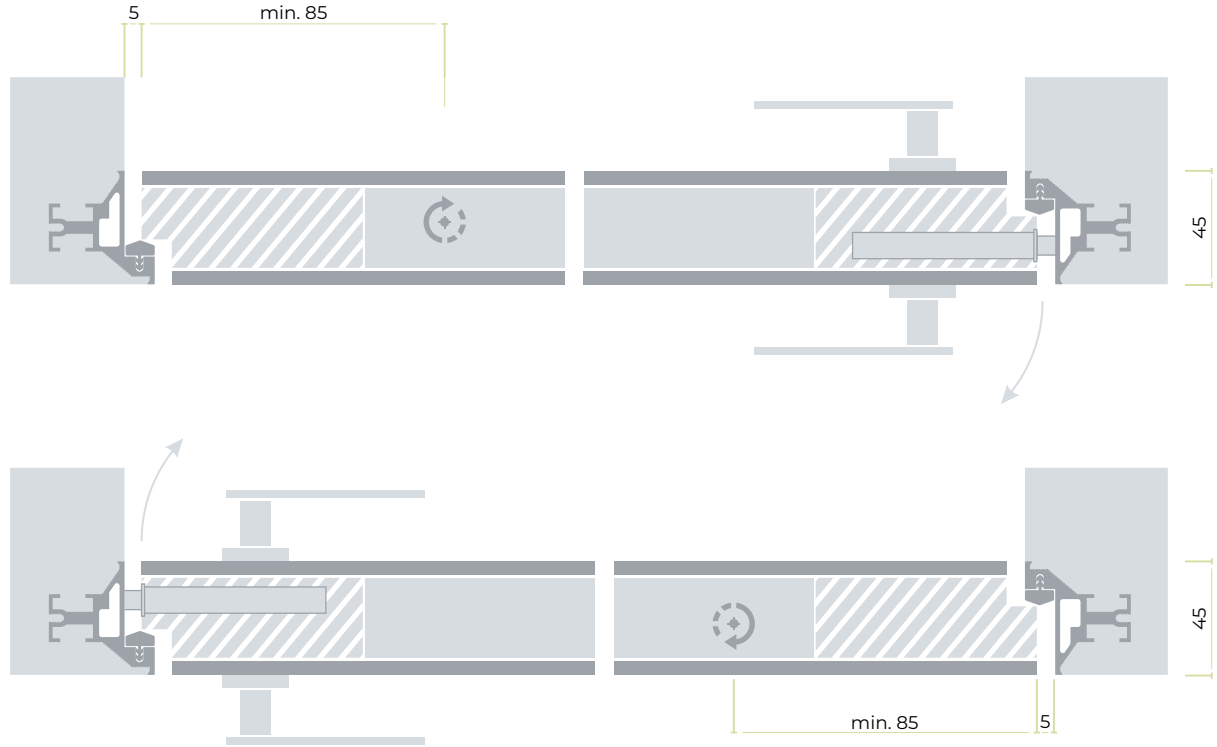



ET GROUP®

Contacts:

info@et-group.com.ua

+38 (068) 162 0 777

+38 (099) 162 0 777

etgroup.ua